

This drawing is the property of MELTRIC Corporation, Franklin (Milwaukee) Wisconsin, USA. Any unauthorized copying of this drawing by any means, ENG/RD/06 REV: 21 ISSUED DATE: 10/7/16 or disclosure of its contents to any person not authorized by MELTRIC Corporation or its agents to receive it, is strictly prohibited.

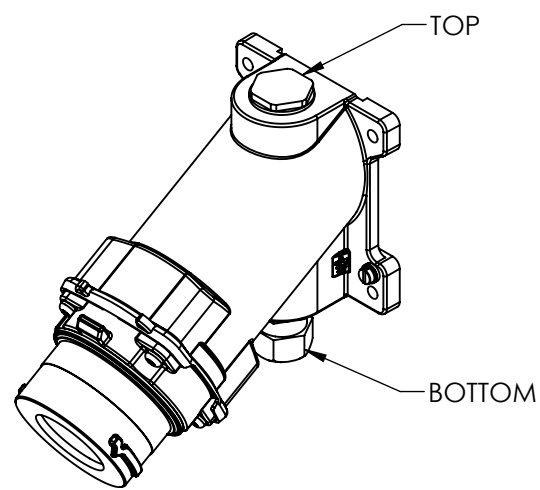
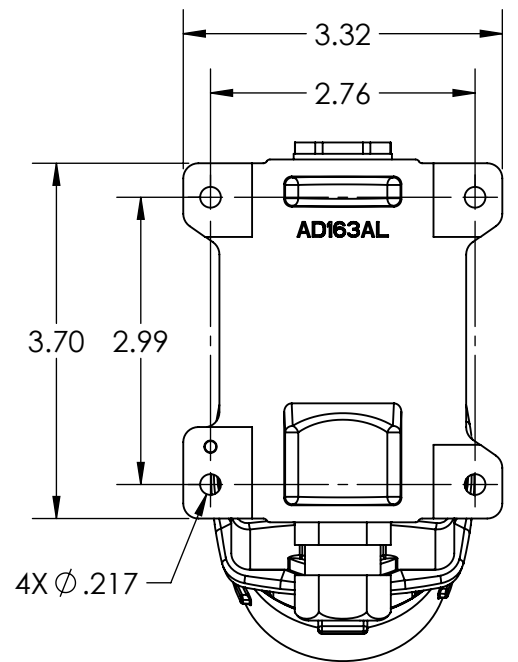
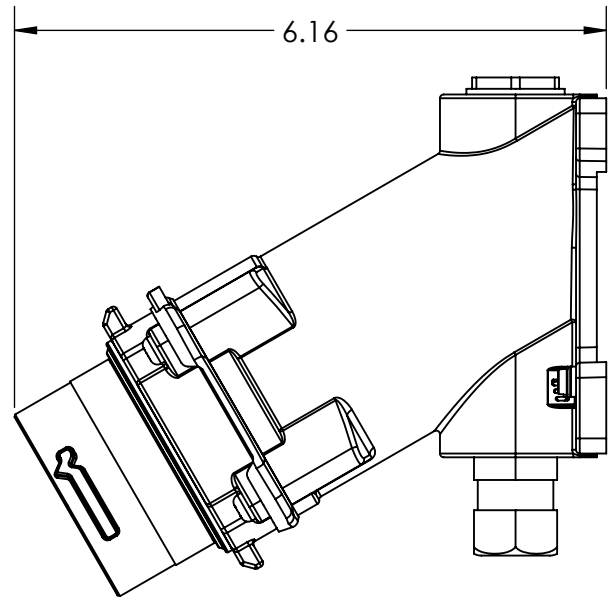
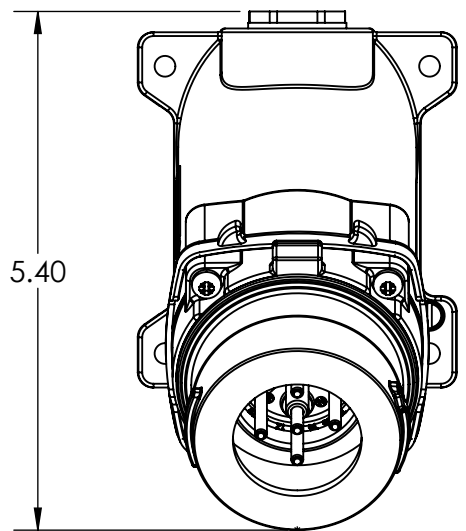

NOTE:
WALL BOX COMES STANDARD WITH 1/2" NPT ON BOTTOM.

SUFFIX	THREADED NPT	LOCATION
12T	1/2" NPT	TOP
34T	1/2" NPT	TOP
34B	1/2" NPT	BOTTOM

TOLERANCES UNLESS OTHERWISE SPECIFIED		 A COMPANY OF MARÉCHAL ÉLECTRIC	
MACHINED SURFACES $\sqrt[125]{\text{MAX}}$ GROUND SURFACES $\sqrt[32]{\text{MAX}}$ ANGLE TOLERANCE $\pm 1^\circ$ REMOVE BURRS & SHARP EDGES TO .015 MAX.	ENGLISH 0.X ± 0.05 0.XX ± 0.01 0.XXX ± 0.005		
DIMENSIONS SHOWN IN OVALS ARE INSPECTION DIMENSIONS.		SCALE: NTS MATERIAL: METAL, BLACK	PART NUMBER: 2816xxxx
SHEET: 1 OF 1		REVISION: _____	