



OPERATING INSTRUCTIONS

DN7C/DN9C/DN20C MULTIPIN

INSDN K

MELTRIC Corporation / 4765 W. Oakwood Park Drive Franklin, WI 53132
Tel.: 800 433 7642 / Fax: 414 433 2701 / e-mail: mail@meltric.com

A manufacturer of products using **Marechal technology**



meltric.com

GENERAL

MELTRIC's DN7c, DN9c and DN20c Series industrial, multipin plugs and receptacles are designed to ensure safety and provide reliable electrical connections. Please follow the instructions below to ensure proper installation and safe use of the product.

WARNING There are inherent dangers associated with electrical products. Failure to follow safety precautions can result in serious injury or death. These instructions must be followed to ensure the safe and proper installation, operation and maintenance of the MELTRIC devices. Before installation, disconnect all sources of power to the circuit to eliminate the risk of electrical shock.

RATINGS

The DN9c and DN20c products are manufactured and load-break rated in compliance with CSA Standard C22.2 No. 182.1. The DN7c product is manufactured and rated in compliance with CE Standards IEC 60309-1. The product ratings are indicated on the device's labels. Additionally the DN9c and DN20c are HP rated for multiple HP loads as long as any single HP load doesn't exceed the levels shown in Table 1. Their short circuit withstand levels and fuse ratings are shown in Table 2.

Table 1 — Maximum HP at Rated Voltage Levels

Device	1-Phase					
	120 V		208 V		240 V	
	HP	FLA	HP	FLA	HP	FLA
	(A)	(A)	(A)	(A)	(A)	(A)
DN9c	1/2 9.8	1 8.8	1.5 10	2 10	3 8.5	
DN20c	1/6 4.4	1/3 4	1/2 4.9	1/2 3.9	1.5 5	
Device	3-Phase					
	208 V		240 V		480 V	
	HP	FLA	HP	FLA	HP	FLA
	(A)	(A)	(A)	(A)	(A)	(A)
DN9c	2 7.5	3 9.6	5 7.6			
DN20c	1 4.6	1 4.2	3 4.8			

Table 2 — Short Circuit Withstand Ratings

Device	Rating Fuse	Type*
DN9c	10 kA @ 480 VAC	RK1 NTD 35 A
		RK5 TD 20 A
DN20c	10 kA @ 480 VAC	RK1 NTD 35 A
		RK5 TD 20 A

*Ratings applies with fusing up to this amperage. Ratings are based on tests performed with Ferraz Shawmut current limiting fuses.

INSTALLATION

! These products should be installed by qualified personnel in accordance with all applicable local, state and national electrical codes. Before starting, verify that the power is turned off; the product ratings are appropriate for the application; and the conductor sizes are within the capacities of the terminals noted on Table 3.

Table 3 — Wiring Terminal Capacity* (in AWG)

Device	Contacts	
	Min	Max
DN7c (50A)	10	6
DN9c	16	10
DN20c	16	10

*Capacity is based on THHN wire sizes.

General Notes & Precautions

- Self-tapping screws are provided for use with some polymeric accessories. **NOTICE:** Once they are seated, care should be taken in order to avoid over-tightening them against the plastic material.
- Various handles, cord grips or strain relief options may be used. These instructions are based on handles provided with integral, multi-layer, bushing cord grips.
- Wire strip lengths are indicated in Table 4. Strip lengths for cable sheathing will depend on the specific application.



Table 4 - Wire Strip Length - Dimensions A

Device/Contacts	Receptacle		Plug/Inlet	
	Inches	mm	Inches	mm
DN7c (50A) Contact	3/4	20	3/4	20
DN9c Contacts	1/2	13	1/2	13
DN20c Contacts	1/2	13	1/2	13

- Wiring terminals are spring-assisted to prevent loosening due to wire strand settlement, vibration and thermal cycling. **NOTICE:** They should not be over-tightened. Appropriate tools and tightening torques are indicated in Table 5.

Table 5 - Terminal Screw Tightening Torques

Device/Contact	Torque		Required Screwdriver or Allen Wrench
	in-lbs	N-m	
DN7c (50A) Contact	13.3	1.5	5/64" hex head 2mm hex head
DN9c Contact	4.50	0.5	5/64" hex head 2mm hex head
DN20c Contact	4.50	0.5	5/64" hex head 2mm hex head

The DN9c and DN20c plugs and receptacles' contacts are labeled with F or S numbers respectively. The F-number on the inlet has a corresponding S-number on the receptacle. See table 6 for details.

Table 6 - DN9c & DN20c Wiring

Plug/Inlet Contact Nos.	Corresponding mating pin	Receptacle Contact Nos.
F1 (Ground)	→	S1 (Ground)
F2	→	S2
F3	→	S3
F4-19	→	S4-19
F20	→	S20

Assembly for In-line Connections

! Do not overtighten terminal or self-tapping screws. Tighten screws to the proper torque to ensure a secure connection.

When the DN9 and 50A DN7c products are used as in-line connectors, finger drawplates should be installed on both the receptacle and plug in order to provide the user with the leverage to connect the device (finger drawplates are not available).

NOTICE: The longer screws provided with the finger drawplates must be used when assembling devices with finger drawplates because the shorter screws provided with the handle are not long enough to properly secure both the handle and drawplates to the inlet or receptacle and achieve a watertight connection.

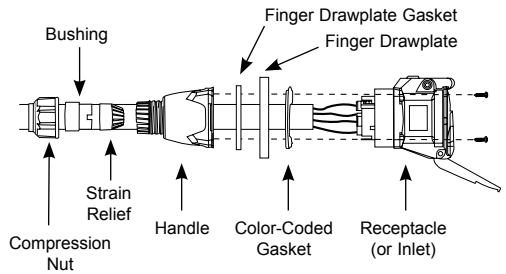

Adjust the bushing diameter to fit the cable by removing the inner sections as required. Insert the bushing into the strain relief, then insert the assembly into the handle and loosely install the compression nut. Insert the cable through the handle, the thin black (neoprene) drawplate gasket, the finger drawplate (if applicable) and the color coded gasket. Strip the cable sheath to provide a workable wire length, being mindful that the sheath must extend into the handle to achieve a secure cord grip. Then strip the individual wires to the lengths indicated in Table 2 and twist the strands of each conductor together.

Back out the terminal screws on the receptacle (or inlet) far enough (but not completely) to allow the conductors to pass. Insert the conductors fully into their respective terminals and tighten the terminal screws with the appropriate tool to the torque indicated in Table 3.

Verify that the cable sheath extends beyond the strain relief and into the handle. Assemble the receptacle (or inlet), the color coded gasket, followed by the finger drawplate, and the thin black (neoprene) drawplate gasket (if applicable) to the handle and tighten the compression nut to secure the cable.

Assembly for Mounted Receptacles (or Inlets)

In applications where the receptacles (or inlets) are mounted to wall boxes, panels or other equipment, optimal operation is achieved when the devices are installed with the latch at the top.

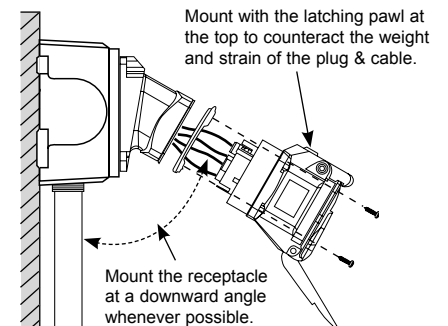

Insert the cable or wires through the wall box and cut to allow adequate length. Strip the cable sheath as

desired, then strip the individual wires to the lengths indicated in Table 2 and twist the strands of each conductor together. Back out the terminal screws on the receptacle (or inlet) far enough (but not completely) to allow the conductors to pass. Insert the conductors fully into their respective terminals and hand tighten the terminal screws to the torque indicated in Table 3.

Assemble the receptacle (or inlet) and the color coded gasket to the box with the appropriate hardware. Assemble the mating plug (or receptacle) to the cord end as indicated in the assembly instructions above for in-line connections, except there will be no finger drawplate or associated black gasket.

Hole Pattern for Custom Mounting

In applications where custom mounting to a panel or box is desired, the clearance and mounting holes should be drilled as indicated in the following diagram and Table 7.

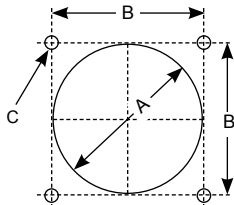

Table 7 - Custom Mounting Dimensions						
Model	'A'		'B'		'C'	
	Inches	mm	Inches	mm	Inches	mm
DN7c (50A)	3.25	83	2.59	66	.22	5.5
DN9c	2.70	69	2.18	55	.19	4.8
DN20c	4.00	102	3.20	81	.22	5.5

NOTICE: In order to maintain the IP protection provided by DN models in custom installations, water-tight seals should be used under the heads of the four mounting bolts and they must be retained by a lock washer and nut on the inside of the box or panel. Alternatively, four blind holes may be drilled and threaded to accommodate the mounting screws, provided that the hole depth is sufficient to achieve adequate gasket compression.

OPERATION

⚠ To ensure safe and reliable operation, MELTRIC plugs and receptacles must be used in accordance with their assigned ratings.

They can only be used in conjunction with mating receptacles or plugs manufactured by MELTRIC or another licensed producer of products bearing the **Marechal**™ technology trademark.

MELTRIC plugs & receptacles are designed with different keying arrangements so that only plugs and receptacles with compatible contact configurations and electrical ratings will mate with each other.

Connection

To connect a plug and receptacle, first depress the pawl to open the lid on the receptacle and orient the plug as shown in figure 1. Push the plug partially into the receptacle until it hits a stop and then rotate the plug in the counter-clockwise direction about 30°. At this point, the circuit is still open. Push the plug straight into the receptacle 2 until it becomes securely latched in place. The electrical connection is now made. For in-line connections, the use of finger drawplates is recommended. When finger drawplates are used, squeeze the drawplates on both sides of the device together until the plug latches in place.

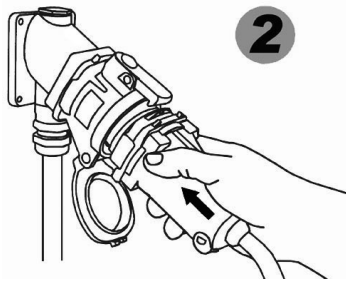
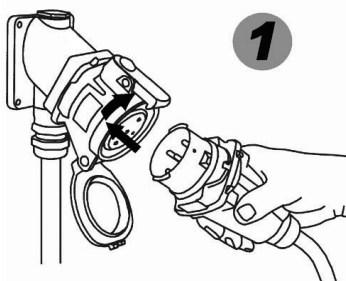

Disconnection

To disconnect, simply depress the pawl 3. This will open the circuit and eject the plug straight out to the rest or off position. The plug contacts are de-energized at this point. To remove the plug, rotate it clockwise about 30° until it releases from the receptacle 4. Close and latch the lid on the receptacle.

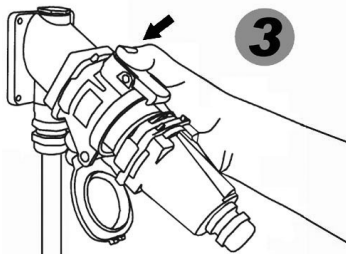

Achieving Rated Watertightness

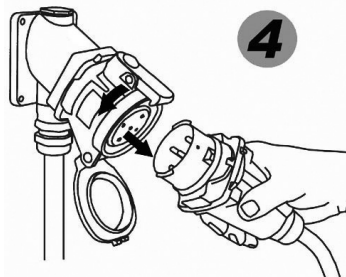

Rated ingress protection applies to the device when the plug and receptacle are mated and latched together. It also applies to the receptacle when the lid is latched closed.

Lockout Provisions

Some MELTRIC receptacles may be purchased with optional lockout provisions. To lockout the receptacle, close and latch the lid and then attach the locking device through the hole provided in the pawl or shroud. This will prevent the lid from being opened for the insertion of a plug.

NOTICE: Attaching the receptacle locking device with the receptacle lid open will not prevent the insertion of a plug. Lockout is only accomplished when the lid is locked closed.

MAINTENANCE

⚠ WARNING Before inspecting, repairing, or maintaining MELTRIC products, disconnect electrical power to the receptacle to eliminate the risk of electrical shock.

MELTRIC products require little on-going maintenance. However, it is a good practice to periodically perform the following general inspections:

- Check the mounting screws for tightness.
- Verify that the weight of the cable is supported by the strain relief mechanism and not by the terminal connections.
- Check the IP gaskets for wear and resiliency. Replace as required.
- Verify the electrical continuity of the ground circuit.
- Check the pin contact surfaces for cleanliness and pitting.

Deposits of dust or similar foreign materials can be rubbed off the contacts with a clean cloth. Sprays should not be used, as they tend to collect dirt. If any significant pitting of the contacts or other serious damage is observed, the device should be replaced.

Receptacle contacts may be inspected by a qualified technician. This should only be done with the power turned off. The inlet contacts can be inspected by pressing on opposite ends of the numbered face. This will make it easier to check the contacts for pitting or damage.

MANUFACTURER'S RESPONSIBILITY

MELTRIC's responsibility is strictly limited to the repair or replacement of any product that does not conform to the warranty specified in the purchase contract. MELTRIC shall not be liable for any penalties or consequential damages associated with the loss of production, work, profit or any financial loss incurred by the customer.

MELTRIC Corporation shall not be held liable when its products are used in conjunction with products not bearing the **Marechal**™ technology trademark. The use of MELTRIC products in conjunction with mating devices that are not marked with the **Marechal**™ technology trademark shall void all warranties on the product.

MELTRIC Corporation is an ISO 9001 certified company. Its products are designed, manufactured and rated in accordance with applicable UL, CSA and IEC standards. MELTRIC designs and manufactures its products in accordance with Marechal keying standards established to ensure intermateability with similarly rated products manufactured by Marechal Electric Group.