

SPeX

Hazardous Location



Main Advantages

- Mechanical keying system prevents intermating of phases
- Reliable mechanical and electrical interlocking
- Automatic IP65/IP66 when plug is mated

- Features and Ratings p. 224
- SPeX p. 225
- Dimensions p. 226

SCAN ME >>



PRODUCT FEATURES



Hazardous location rating is based on mandatory use of pilot circuit to make and break load on phase contacts.

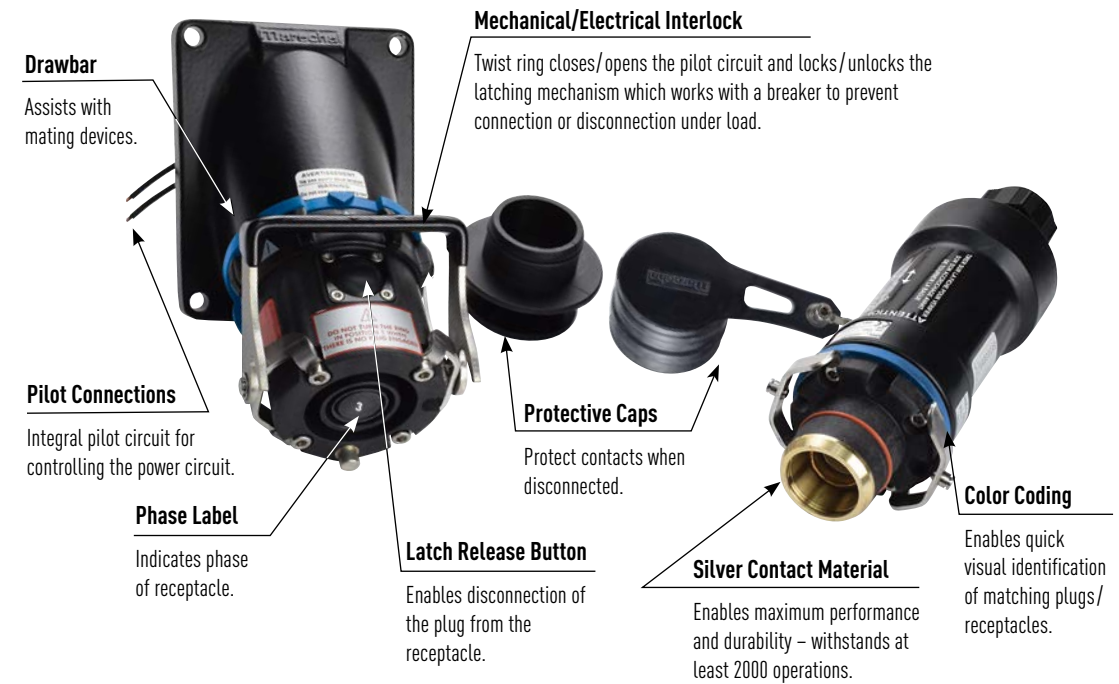

Hazardous Location Listings (CSA or ATEX)

CSA	ATEX
Class I, Division 2, Group ABCD	II 2 G D Ex e IIC T* Gb Ex tIIIC T* Db IP65/IP66 Suitable for Zone 1 & 2 (gas) 21 & 22 (dust)
Class II, Division 1 Groups EFG; Class III, Division 1	
Ex e IIC; Ex tb IIIC T56°C or T76°C IP66 (For Canada)	-20°C ≤ Ta ≤ 40°C T5 T56°C
Class I, Zone 1, AEx e IIC T5 or T6	-20°C ≤ Ta ≤ 60°C T5 T76°C
AEx tb IIIC T56°C or T76°C	-20°C ≤ Ta ≤ 40°C T6 T56°C
IP65/IP66 (For US)	-20°C ≤ Ta ≤ +60°C T4 T79°C

NOM listing available. Contact Engineering for more information.

Amperage Ratings by Cable Size and ATEX Rating

	-20°C ≤ TA ≤ 40°C	-20°C ≤ TA ≤ 40°C	-20°C ≤ TA ≤ 60°C
	G/D T5/T56°C	G/D T6/T56°C	G/D T5/T76°C
70mm ²	290 A	235 A	235 A
95mm ²	415 A	335 A	335 A
120mm ²	456 A	376 A	376 A
150mm ²	493 A	415 A	415 A
185mm ²	530 A	450 A	450 A
240mm ²	570 A	497 A	497 A
300mm ²	620 A	540 A	540 A
400mm ²	680 A	600 A	600 A

Operating Instructions



To connect, insert the plug into the receptacle until a click is heard. Rotation of the plug in either direction engages a locking finger, which prevents further rotation.



To close the pilot circuit and mechanically lock the plug into the receptacle, turn the ring on the receptacle until the "1" lines up with the arrow. This turns the power on.



To disconnect, open the pilot circuit and unlock the plug by turning the ring until the "0" is aligned with the arrow. The power is now off.



Press firmly on the latch release button and simultaneously pull on the inlet. A slight rotation of the plug may also be required.

Accessories rated for hazardous locations are not returnable.

cSAUs Ratings

- Voltage**
600 VAC
- Amperage Ratings**
600 A
- Environmental Ratings**
IP65/IP66
- Temperature Range**
See table page 254
- Wiring Capacity**
Min 2/0 AWG Max 750 MCM
Aux Contacts 12-14 AWG
See table page 224
- Applicable Standards**
CSA C22.2 No. 182.1,
CSA 213-M1987, CSA 25-1966

Devices rated for hazardous locations are not returnable.

Plug
(male inlet w/handle)



Receptacle on Angle
(female)



North American cSAUs Configurations

COLOR CODE	POLARITY	PART # WITHOUT LUG (BY CABLE DIAMETER)				PART # WITHOUT LUG
		.700-.980"	.960-1.330"	1.330-1.650"	1.570-1.890"	
Black	L1	42-41001-32P	42-41001-40P	42-41001-50P	42-41001-63P	42-47001
Red	L2	42-41002-32P	42-41002-40P	42-41002-50P	42-41002-63P	42-47002
Blue	L3	42-41003-32P	42-41003-40P	42-41003-50P	42-41003-63P	42-47003
White	NEUTRAL	42-4100N-32P	42-4100N-40P	42-4100N-50P	42-4100N-63P	42-4700N
Green	GROUND	42-4100T-32P	42-4100T-40P	42-4100T-50P	42-4100T-63P	42-4700T
Red	POSTIVE	42-4100P-32P	42-4100P-40P	42-4100P-50P	42-4100P-63P	42-4700P
Black	NEGATIVE	42-4100M-32P	42-4100M-40P	42-4100M-50P	42-4100M-63P	42-4700M

Use with angle 45° or direct mount

(Bolt Included)



Use with handle for cord mounting



CRIMPING LUGS

INTERNAL DIAMETER	STRAIGHT w/TERMINAL		STRAIGHT THREADED	FLEXIBLE WIRING*	COARSE WIRING
	in	mm	PART #	PART #	AWG
.43	11		454A50C	454A50D	1/0
.51	13.1		454A70C	454A70D	2/0, 3/0
.57	14.5		454A95C	454A95D	4/0
.64	16.2		454A12C	454A12D	262
.71	18		454A15C	454A15D	300, 313
.81	20.6		454A18C	454A18D	350*, 373
.91	23.1		454A24C	454A24D	444*, 500, 535
1.03	26.1		454A30C	454A30D	646
1.15	29.2		454A40C	454A40D	750, 777*

Notes: * Class H & I UL Listing performed with Greenlee EK6/DL11 dieless tool and Dewalt DCE300M2 with Greenlee KC12 dies. *Only for use with Greenlee EK6/D11 dieless tool.

ACCESSORIES

DRAWBAR	PART #
	454A376

IEC/CE Ratings

- Voltage**
1000 VAC, 1500 VDC
- Amperage Ratings**
See table page 224
- Environmental Ratings**
IP65/IP66
- Temperature Range**
See table page 254
- Wiring Capacity**
Min 2/0 AWG Max 750 MCM
Aux Contacts 12-14 AWG
See table page 231
- Applicable Standards**
ATEX, IECEx

Plug
(male inlet w/handle)



Receptacle on Angle
(female)



IEC/CE Configurations

COLOR CODE	POLARITY	PART # WITHOUT LUG (BY CABLE DIAMETER)				PART # WITHOUT LUG
		.70 - .98"	.94 - 1.33"	1.33 - 1.65"	1.57 - 1.89"	
Black	L1	464100132P	464100140P	464100150P	464100163P	4647001
Red	L2	464100232P	464100240P	464100250P	464100263P	4647002
Blue	L3	464100332P	464100340P	464100350P	464100363P	4647003
White	NEUTRAL	464100N32P	464100N40P	464100N50P	464100N63P	464700N
Green	GROUND	464100T32P	464100T40P	464100T50P	464100T63P	464700T
Red	POSITIVE	464100P32P	464100P40P	464100P50P	464100P63P	464700P
Black	NEGATIVE	464100M32P	464100M40P	464100M50P	464100M63P	464700M

Dimensions Inlet/Receptacle – Provided in Inches

Dimensions are for reference only and may change depending on accessories used. For precise dimensions contact MELTRIC Engineering.



Inlet

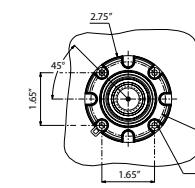

Receptacle

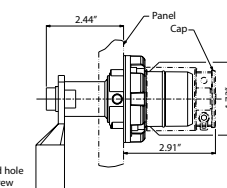

Plug

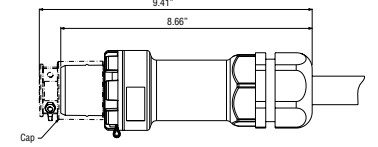

Connector

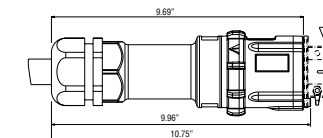

Plug/Connector

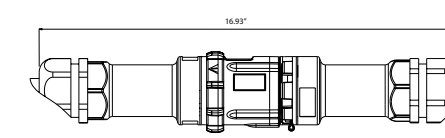

Plug with Connector On/Off

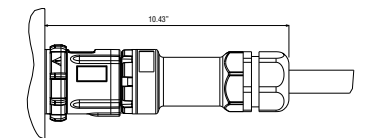

Connector with Plug On/Off

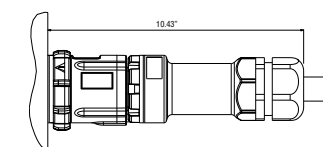

45° Inclined Receptacle/Angle with Plug

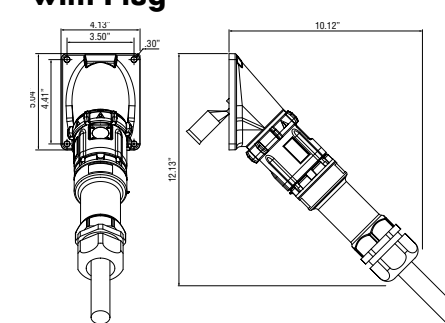

45° Inclined Inlet/Angle with Connector

