

DX DIMENSIONS Inlet – Provided in inches

Dimensions are for reference only and may change depending on accessories used. For precise dimensions contact MELTRIC Engineering.

Plug

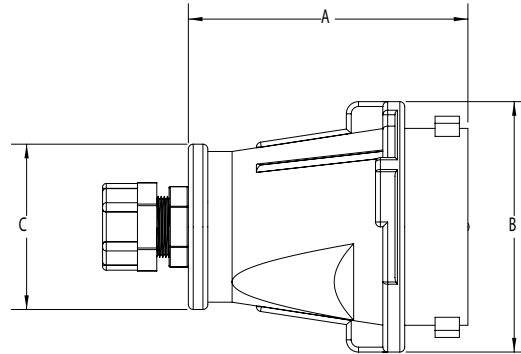

PRODUCT	A	B	C
DX20/DX30	4.53	4.06	2.68
DX60/DX100	8.66	5.75	3.94

Receptacle

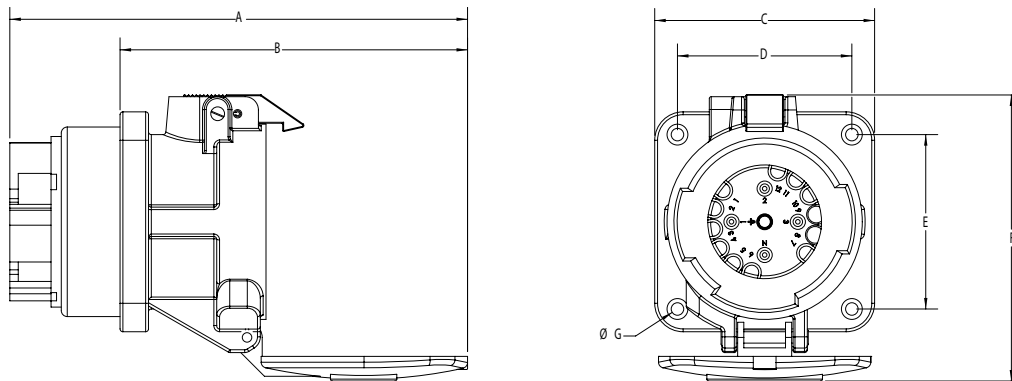

PRODUCT	A	B	C	D	E	F	ØG
DX20/DX30	9.51	7.22	4.57	3.62	3.62	5.94	0.26
DX60/DX100	15.3	11.67	6.3	4.8	4.8	7.95	0.35



Wall Box/ Receptacle/Plug

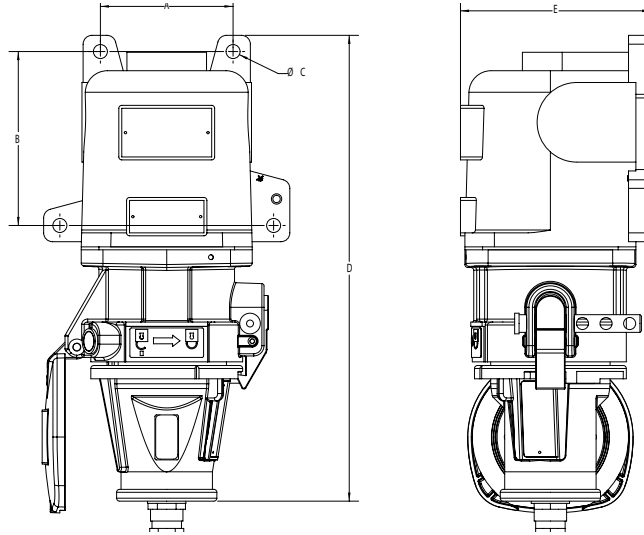

PRODUCT	A	B	C	D	øE
DX20/DX30	3.54	4.65	0.37	12.44	5.08
DX60/DX100	5.12	6.81	0.39	19.06	6.5

Plug/Connector

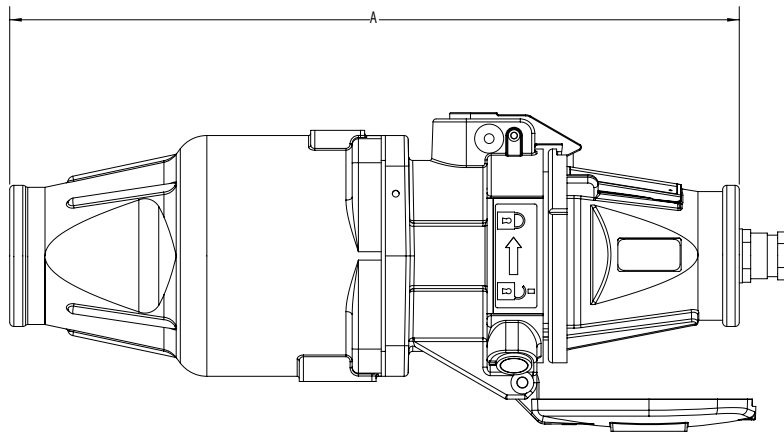

PRODUCT	A
DX20/DX30	13.84
DX60/DX100	21.14

